

THE PROPERTY OF THE DRAWING IS ESTABLISHED BY LAW. IT IS FORBIDDEN TO PRODUCE OR SHOW IT TO THIRD PART. WITHOUT A WRITTEN AGREEMENT.

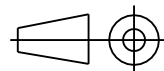
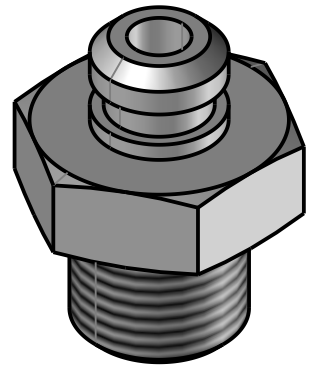
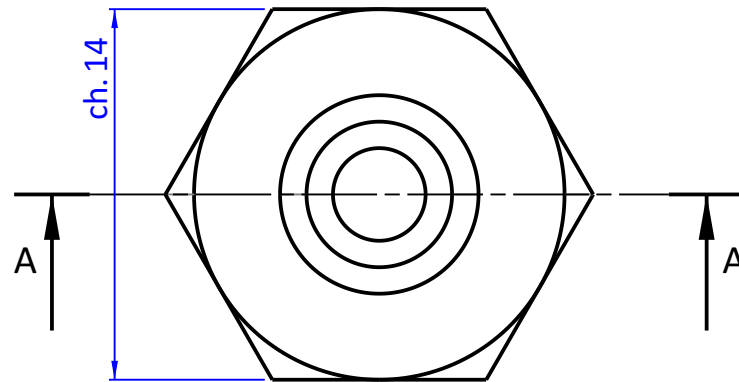
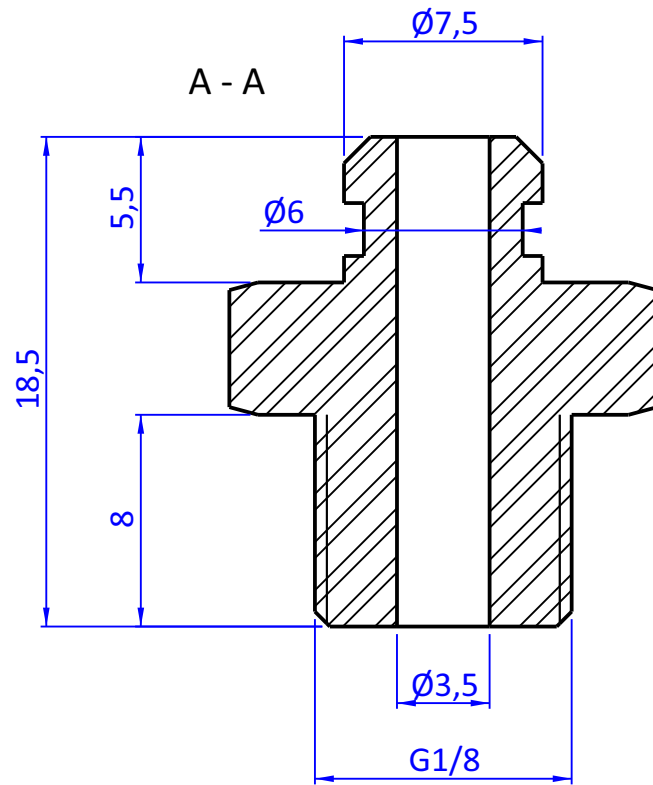

DESIGNED FROM	FPS Automation	REVIEW	A
---------------	----------------	--------	---

DATE	02/09/2022	WEIGHT	0,004kg
------	------------	--------	---------

CODE	CA.08.09.027
------	--------------

Format A4

UNI 936-76

GENERAL TOLERANCE

UNI - ISO 2768

CLASSE f

DESCRIPTION

CA.08.09.027